

Merci d'avoir fait confiance à Akante. Nous apportons le plus grand soin à l'élaboration de nos créations.  
Thank you for choosing Akante. We take great care in the development of our creations.  
Vielen Dank für Ihr Vertrauen in Akante. Bei der Entwicklung unserer Kreationen wenden wir größte Sorgfalt an.

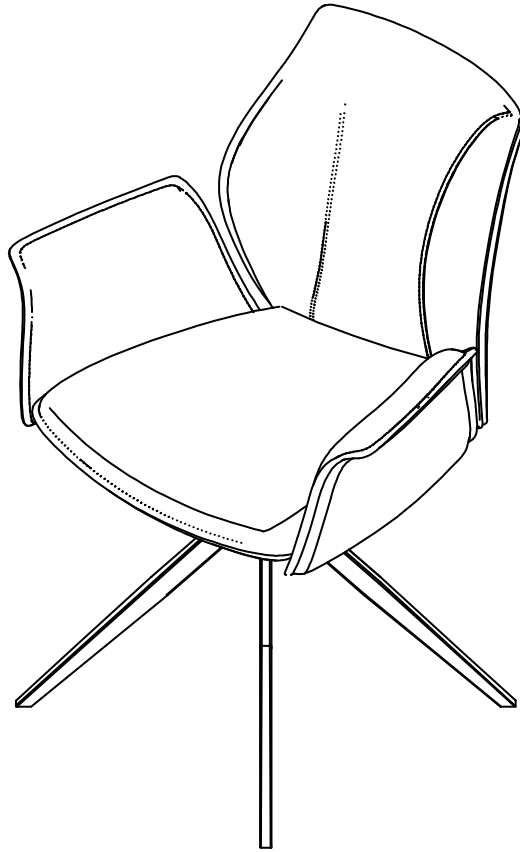

## MODELE : VIENNA





Matériaux : acier/100% tissu polyester  
Materials : steel/100% polyester fabric  
Material : Stahl/100% Polyestergewebe

## REF VIENNA: CH175

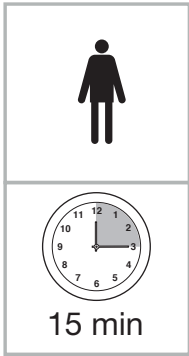
Dimensions/Abmessungen :  
L64 x P60 x H89-50 cm

INSTRUCTIONS D'ASSEMBLAGE / ASSEMBLY INSTRUCTIONS / MONTAGEANLEITUNG  
REGLAGES / SETTINGS / DIE EINSTELLUNGEN  
CONSEILS D'ENTRETIEN / CARE INSTRUCTIONS / PFLEGEHINWEISE  
IMPORTANT : à lire attentivement et à conserver pour consultation ultérieure.  
IMPORTANT : please read carefully and keep for further use.  
WICHTIG : Lesen Sie die Anleitung sorgfältig durch und halten Sie die Anweisungen ein.

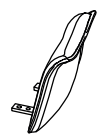

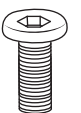
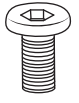
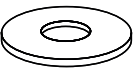
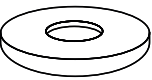
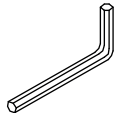
<b>1</b>  x1	<b>2</b>  x1	<b>3</b>  x1	<b>4</b>  x1	<b>5</b> ØM6 x 20  x10
<b>6</b> M6 x 16  x2	<b>7</b> Ø6 x Ø16  x12	<b>8</b> Ø20 x Ø8 x 5  x2	<b>9</b>  x1	

Tenir les enfants à l'écart lors du montage - Ne jamais soulever la table par le plateau.  
 Keep children away during assembly - Do not carry the table upper plate.  
 Kinder bei der Montage fernhalten - Niemals den Tisch an den Platten hochheben.

INSTRUCTIONS D'ASSEMBLAGE / ASSEMBLY INSTRUCTIONS / MONTAGEANLEITUNG

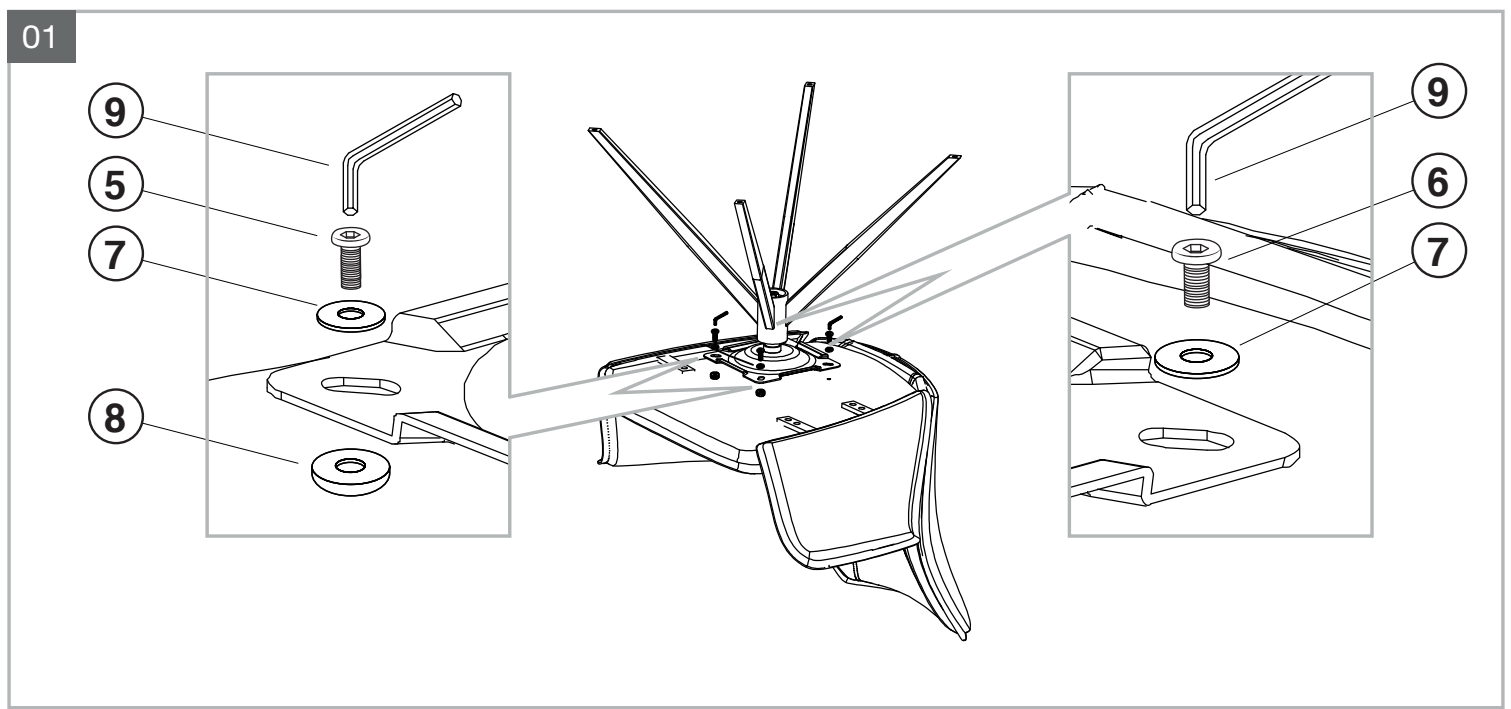
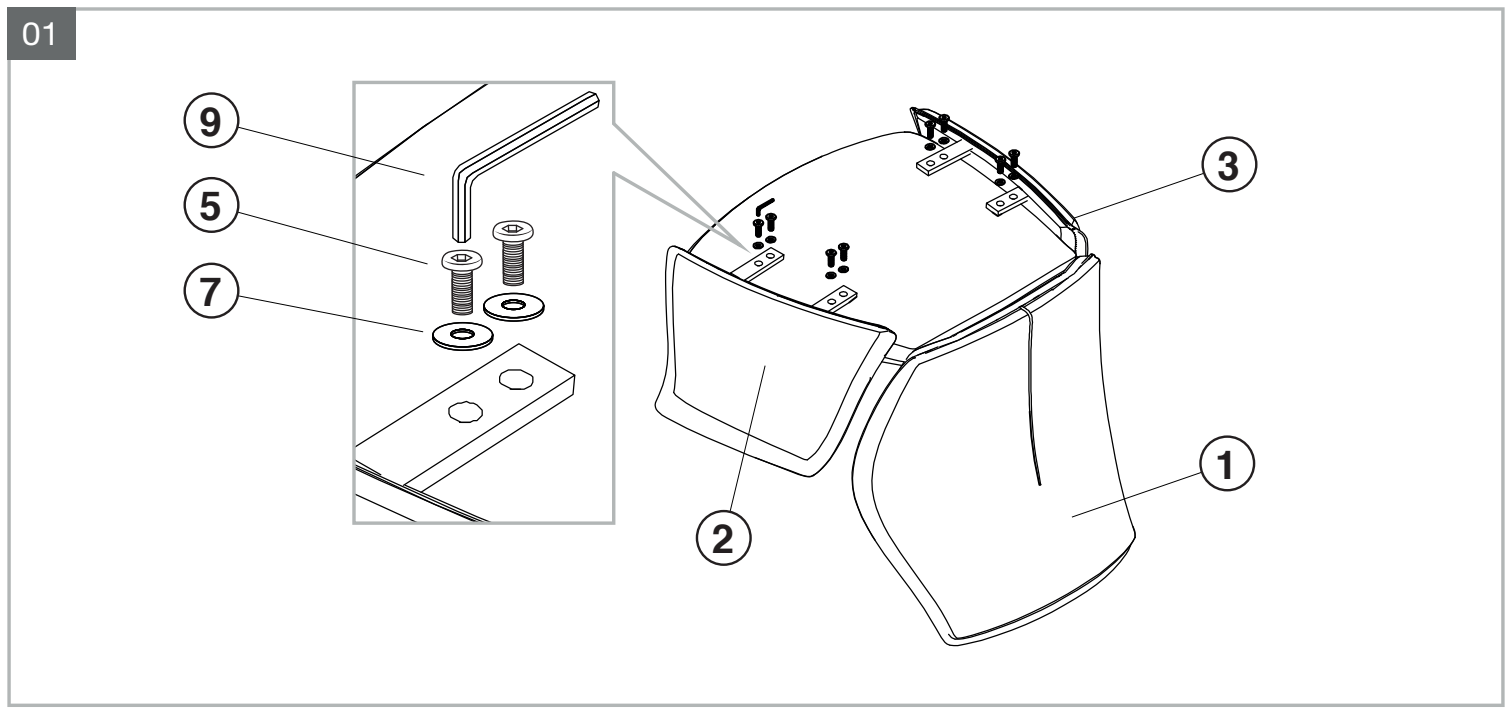

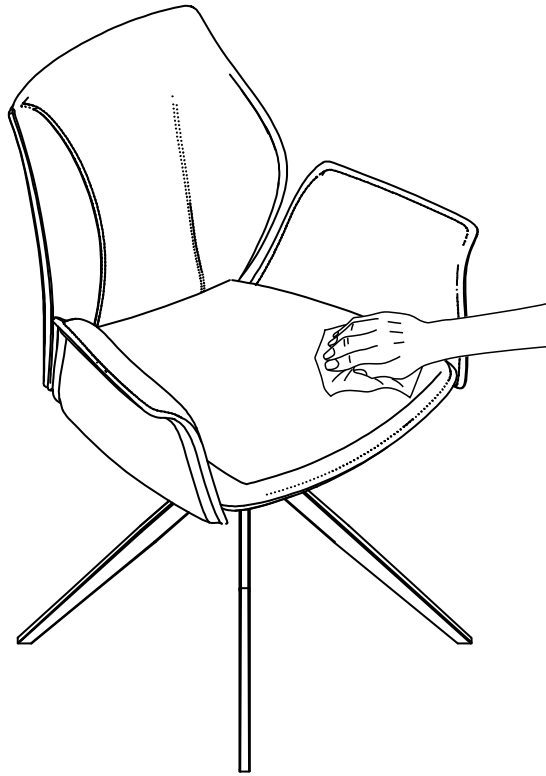

Nettoyer avec un chiffon humide et bien sécher avec un chiffon sec.

Clean with a damp cloth and dry well with a dry cloth.

Mit einem feuchten Tuch reinigen und mit einem trockenen Tuch gut abtrocknen.

Si vous avez un problème lors du montage de votre produit, n'hésitez pas à contacter votre revendeur.  
If you encounter a problem during the assembly of your product, do not hesitate to contact your retailer.  
Wenn Sie während der Montage Ihres Produkts ein Problem haben, wenden Sie sich bitte an Ihren Fachhändler.